

DrillSaw Power™ System

Revolutionizing Power | Product Information



Arthrex®
Vet Systems



Table of Contents

DrillSaw Mini 300™ Power System	04
Attachments	06
DrillSaw Sports 400™ Power System	08
Attachments	10
Micro Sagittal Blades.....	12
Reciprocating Blades.....	13
Burrs	14

DrillSaw Mini 300™ Power System



Features and Benefits:

- Modular design is cost-efficient
- Minimal weight and maximum power
- Excellent balance and ergonomics
- Lubrication not needed
- PEEK housing—durable and lightweight
- Lithium-ion technology—very long battery life
- Intuitive handling
- 1-year warranty on batteries
- Autoclavable









Product Description	Item Number
Handpiece AR-300 (a)	VAR-300
Lithium-ion battery pack for AR-300 (b)	VAR-300L
Aseptic transfer kit for AR-300 (c)	VAR-300ATK
Battery housing for AR-300 (d)	VAR-300LBH

Accessories

Image	Product Description	Item Number
	<p>Universal battery charger for AR-300, AR-400, and AR-600 batteries.</p> <p>Note: The charger will be delivered without charging bays.</p>	<p>VAR-400UBC</p>
	<p>Charging bay for AR-600L and AR-300L</p> <p>Note: For battery type: VAR-300L and VAR-600L; two charging bays will be delivered at a time.</p>	<p>AR-400UBC-3</p>
	<p>DrillSaw Mini 300™ instrument tray</p> <p>Note: Tray holds 1 handpiece, 2 battery housings, 2 aseptic transfer kits, 8 attachments.</p>	<p>AR-300C</p>







Attachments

	Description	Item Number	Connection	RPM	Note
	Sagittal Saw Attachment	VAR-300SAG	VAR-300	15,000* CPM	Arthrex small bone sawblades
	Reciprocating Saw Attachment	VAR-300SR	Round and flat shaft	15,000* CPM	VAR-300 flat shaft or standard round shaft (Ø3.17 mm connection)
	High-Speed Burring Attachment	VAR-300B	Round shaft	15,000* CPM	Round shaft connection: Ø2.35 mm (Dental connection)
	Drill Attachment small AO	VAR-300DAO-2	Small AO	1300	Small AO connection drills up to Ø6 mm
	Drill Hybrid Chuck	VAR-300DJH	0 mm-5 mm	1300	Keyed and keyless chuck drill up to 6 mm
	Drill Keyed, Jacob's Chuck	VAR-300DJ	0 mm-4 mm	1300	Drills up to Ø6 mm
	Medium-Speed Burring Attachment	VAR-300B-2	Round shaft	2750	Round shaft connection: Ø2.35 mm (Dental connection)
	Drill Keyless Chuck	VAR-300DK30	0 mm-3 mm	2750	Accommodates fittings up to 3 mm, drills up to 4 mm
	Drill Keyless Chuck	VAR-300DK45	2 mm-4.5 mm	2750	Accommodates fittings up to 4.5 mm, drills up to 4 mm

Green = drill (1300 RPM), Blue = drill (2750 RPM)

*Cuts Per Minute

Attachments

	Description	Item Number	Connection	RPM	Note
	Reamer Attachment AO	VAR-300RAO	Standard AO	500	Standard AO connection drills up to Ø8 mm, reamer up to Ø20 mm
	Reamer Keyed Chuck	VAR-300RJ	0 mm-4 mm	500	Accommodates fittings up to Ø4 mm drills up to Ø8 mm, reamer up to Ø20 mm
	Wire Driver Attachment	VAR-300WD16	0.6 mm-1.6 mm	2750	Accommodates wires from 0.6 mm-1.6 mm
	Pin Driver Attachment	VAR-300PD24	1.2 mm-2.4 mm	1300	Accommodates pins from 1.2 mm-2.4 mm
	Offset Attachment	VAR-300CA	Arthrex VAR-300 connection	Speed based on attachment connected	Offset adapter for all attachments

Red = reaming (500 RPM)

DrillSaw Sports 400™ Power System

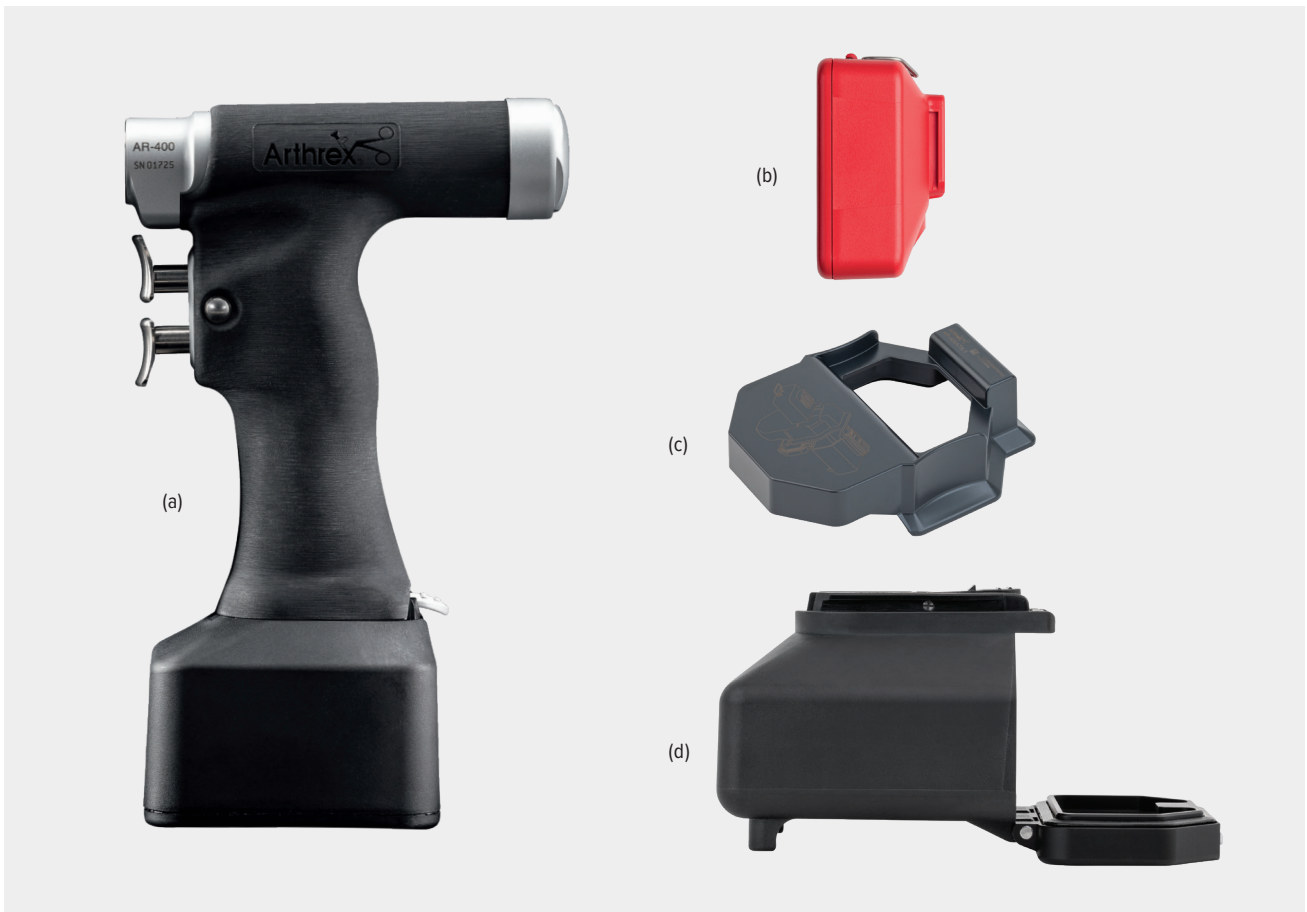



Features and Benefits:

- Modular handpiece for drilling, reaming, and sawing
 - Dual trigger operation
 - Multifunctional
 - Forward
 - Reverse
 - Oscillate drilling
 - Lockout reverse
- Custom texture improves grip during use
- Versatile for trauma and sports medicine
- Li-ion battery technology
- Lightweight, powerful, and perfectly balanced





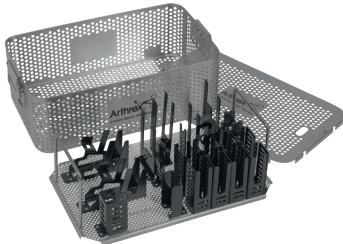





Product Description	Item Number
Handpiece AR-400 (a)	VAR-400
Lithium-ion battery pack for AR-400 (b)	VAR-400UB
Aseptic transfer kit for AR-400 (c)	VAR-400-ATK-1
Battery housing for AR-400 (d)	VAR-400UBH-1

Accessories

Image	Product Description	Item Number
	<p>Universal battery charger for AR-300, AR-400, and AR-600 batteries. Note: The charger will be delivered without charging bays.</p>	<p>VAR-400UBC</p>
	<p>Charging bay for AR-400UB Note: For battery type: VAR-400UB; two charging bays will be delivered at a time</p>	<p>AR-400UBC-4</p>
	<p>DrillSaw Sports 400™ instrument case, 1 handpiece Note: Tray holds 1 handpiece, 2 battery housings, 2 aseptic transfer kits, 1 wire/pin driver, 8 attachments.</p>	<p>AR-400AC-1</p>



Attachments

	Description	Item Number	Connection	RPM	Note
	Sagittal Saw Attachment	VAR-400SAG	Arthrex small bone sawblades	23,000* CPM	Arthrex small bone sawblades
	Drill Attachment AO style	VAR-400DAO	Standard AO	1330	Standard AO connection
	Drill Keyless Chuck 0.6 mm-7.4 mm	VAR-400DK74	0.6 mm-7.4 mm	1330	Accommodates fittings up to Ø7.4 mm
	Drill Jacob's Chuck 0 mm-4 mm	VAR-400DJ40	0 mm-4 mm	1330	Accommodates fittings up to Ø4 mm
	Drill Keyed Chuck 0 mm-7.4 mm	VAR-400DJ74	0 mm-7.4 mm	1330	Accommodates fittings up to Ø7.4 mm
	Drill Jacob's Chuck hybrid 0 mm-5 mm	VAR-400DJH50	0 mm-5 mm	1330	Accommodates fittings up to Ø5 mm
	Drill Jacob's Chuck hybrid 0 mm-7.4 mm	VAR-400DJH74	0 mm-7.4 mm	1330	Accommodates fittings up to Ø7.4 mm
	Drill Attachment Zimmer/Hudson	VAR-400DZH	Zimmer and Hudson	1330	Drill attachments: Zimmer and Hudson
	Drill Attachment Trinkle	VAR-400DT	Trinkle	1330	Trinkle fitting only
	Drill Attachment Harris	VAR-400DHA	Harris	1330	Drill attachments: Harris







Silver = reaming (23,000 RPM), Blue = drill (1300 RPM)

*Cuts Per Minute

Replacement Parts:

VAR-300KEY: Replacement key for Jacobs chuck up to 4.0 mm

Attachments

	Description	Item Number	Connection	RPM	Note
	Adapter For Radiolucent Angular Drive	VAR-400ARL		1330	Adapter for radiolucent angular drive from Synthes
	Pin Driver Attachment 0 mm-3.2 mm	VAR-400PD	0 mm-3.2 mm	1330	Accommodates pins and wires from 0.6 mm-3.2 mm
	Reamer Attachment Zimmer/Hudson style	VAR-400RZH	Zimmer and Hudson	330	Reamer attachments: Zimmer and Hudson
	Reamer attachment Large AO	VAR-400RAOP	Large AO	330	Reamer attachments: Large AO
	Reamer Attachment Hudson style	VAR-400RHU	Hudson	330	Reamer attachment: Hudson (DePuy Synthes)
	Reamer Jacob's Chuck 0 mm-7.4 mm	VAR-400RJ74	0 mm-7.4 mm	330	Accommodates fittings up to Ø7.4 mm
	Reamer Jacobs Chuck hybrid 0 mm-7.4 mm	VAR-400RJH74	0 mm-7.4 mm	330	Accommodates fittings up to Ø7.4 mm
	Reamer attach style DHS (Dynamic Hip Screw)	VAR-400DHS	DHS	330	DHS style (Dynamic Hip Screw)
	Burr Attachment 2.35 mm	VAR-400B		21,300	Round shaft connection: Ø2.35 mm
	J-latch and Dental 2.35 mm	VAR-400JLD		5300	Round shaft connection: Ø2.35 mm

Blue = drill (1300 RPM), Red = reaming (330 RPM)

Micro Sagittal Blades | Used With AR-300SAG, AR-400SAG



Length	Width	Thickness	Item Number
40 mm	14 mm	0.6 mm (a)	AR-300-040S
40 mm	9.5 mm	0.6 mm (b)	AR-300-041S
25 mm	9.4 mm	0.7 mm (c)	AR-300-042S
25 mm	9.4 mm	0.6 mm (d)	AR-300-043S
25 mm	5.5 mm	0.6 mm (e)	AR-300-044S
16 mm	5.5 mm	0.6 mm (f)	AR-300-045S
17 mm	9.4 mm	0.65 mm (g)	AR-300-046S
18.5 mm	10 mm	0.55 mm	AR-300-047S
19 mm	10 mm	0.55 mm (h)	AR-300-048S

ACTUAL SIZE

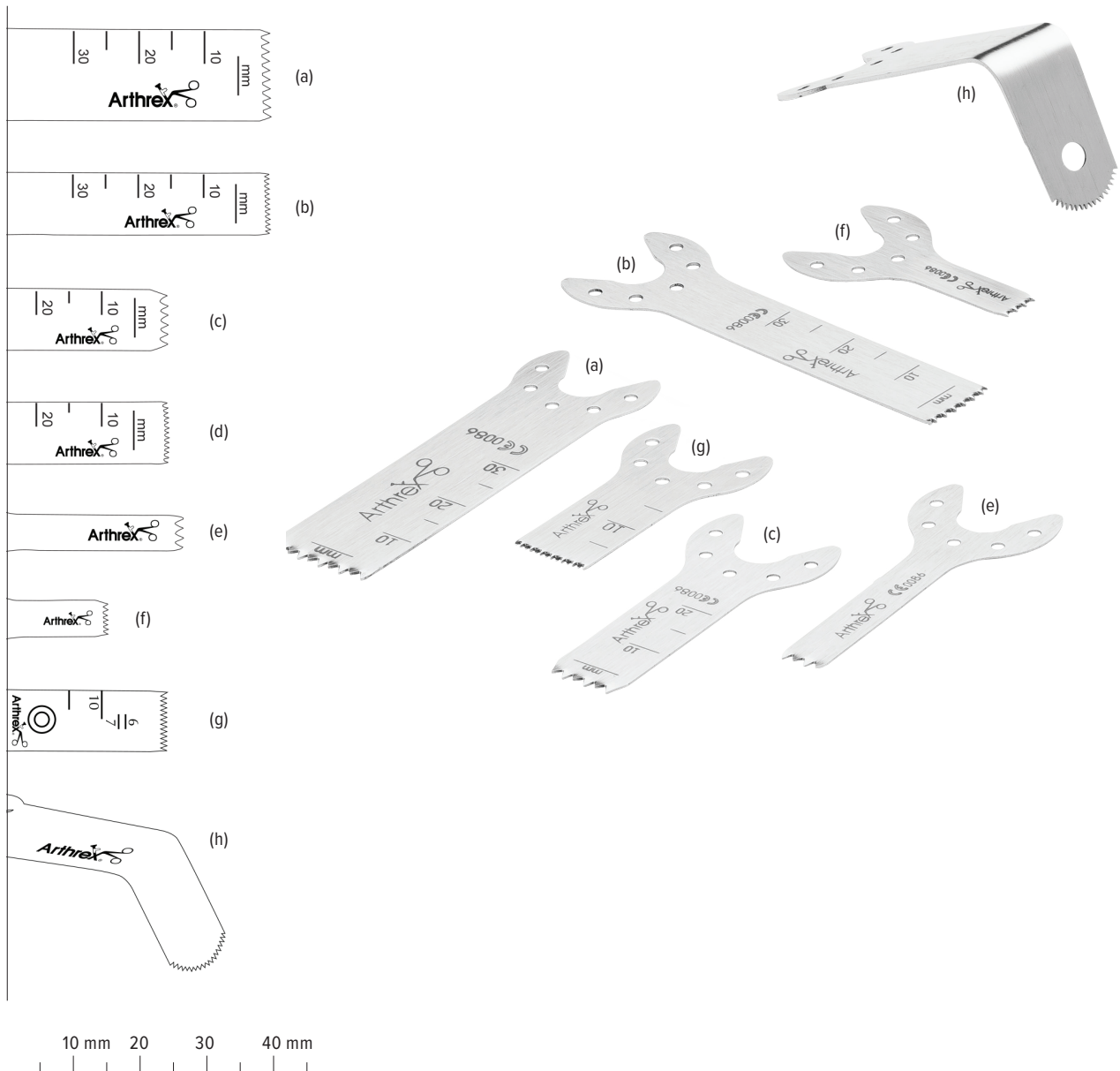

Reciprocating Blades | Used With AR-300SR



Length	Width	Thickness	Item Number
15 mm	6 mm	0.6 mm (a)	AR-300-050S
25 mm	6 mm	0.6 mm (b)	AR-300-051S
40 mm	6 mm	0.6 mm (c)	AR-300-052S

ACTUAL SIZE

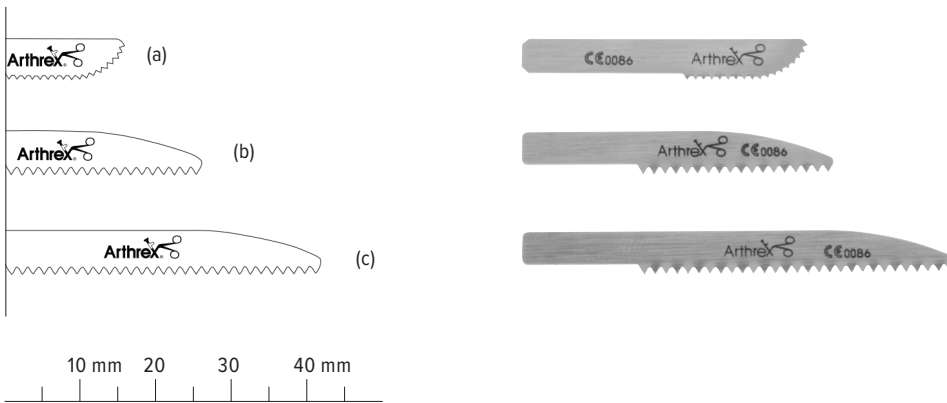

Burrs



Length	Width	Notes	Item Number
13 mm	Ø2 mm	Straight/Shannon Recta (a)	AR-300-B001
8 mm	Ø2 mm	Straight/Shannon Corta (b)	AR-300-B002
12 mm	Ø2 mm	Straight/Shannon Larga (c)	AR-300-B003
12 mm	Ø2.2 mm	Conical/Shannon 43 (d)	AR-300-B004
13 mm	Ø2.9 mm	Conical/Wedge 4 (e)	AR-300-B101
13 mm	Ø2.9 mm	Straight/Wedge 3 (f)	AR-300-B102
15 mm	Ø5 mm	Oval/Brophy (g)	AR-300-B103
19.5 mm	Ø2 mm	Straight/Shannon Recta 2.0 long (h)	AR-300-B201
20 mm	Ø3.1 mm	Straight/Shannon (i)	AR-300-B202





This is not veterinary advice and Arthrex recommends that veterinarians be trained in the use of any particular product before using it in surgery. A veterinarian must always rely on his or her own professional clinical judgment when deciding whether to use a particular product. A veterinarian must always refer to the package insert, product label and / or instructions for use before using any Arthrex product. Products may not be available in all markets because product availability is subject to the regulatory and / or veterinary practices in individual markets. Please contact your Arthrex representative if you have questions about availability of products in your area.

arthrexvetsystems.com

© 2024-08 Arthrex, Inc. All rights reserved. VLB1-00130-EN_C



Arthrex manufacturer,
authorized representative,
and importer information
(Arthrex eIFUs)



US patent information